

B SECTION
SCALE 1/20

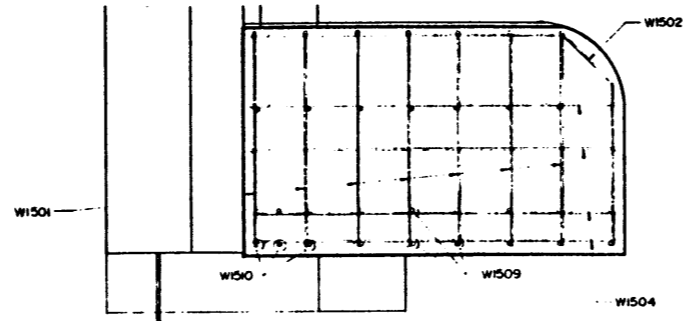

A SECTION
SCALE 1/20

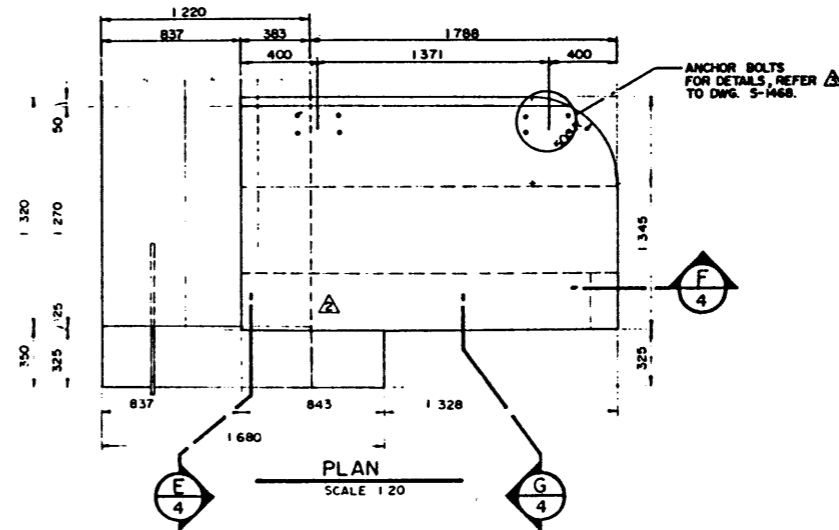

PLAN
SCALE 1/20

NOTE:
WINGWALL AND SIDEWALK TO BE MADE WITH BROWN CEMENT.
28 DAY CONCRETE STRENGTH 25 MPa
ALL REINFORCING STEEL TO BE CSA G30.12M-400.

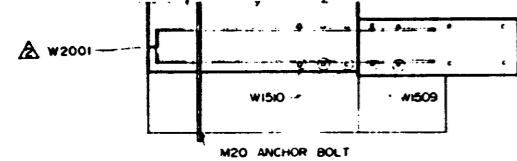

C SECTION
SCALE 1/20

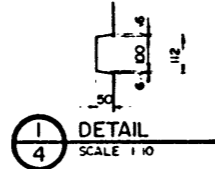

1 DETAIL
SCALE 1/10

PRECAST WINGWALL PANEL

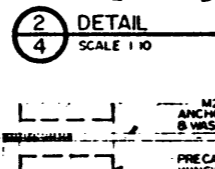

2 DETAIL
SCALE 1/10

6x150x150 STEEL PLATE

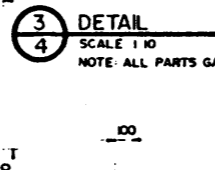

3 DETAIL
SCALE 1/10
NOTE: ALL PARTS GALVANIZED

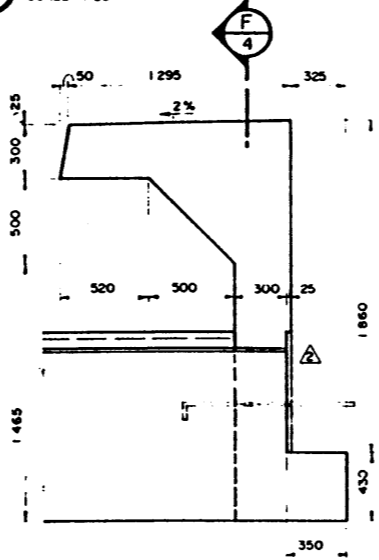
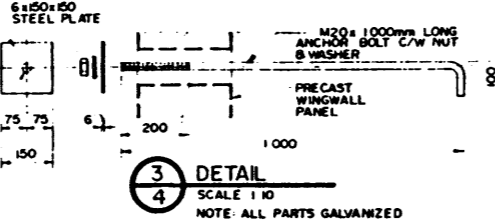

ELEVATION
SCALE 1/20

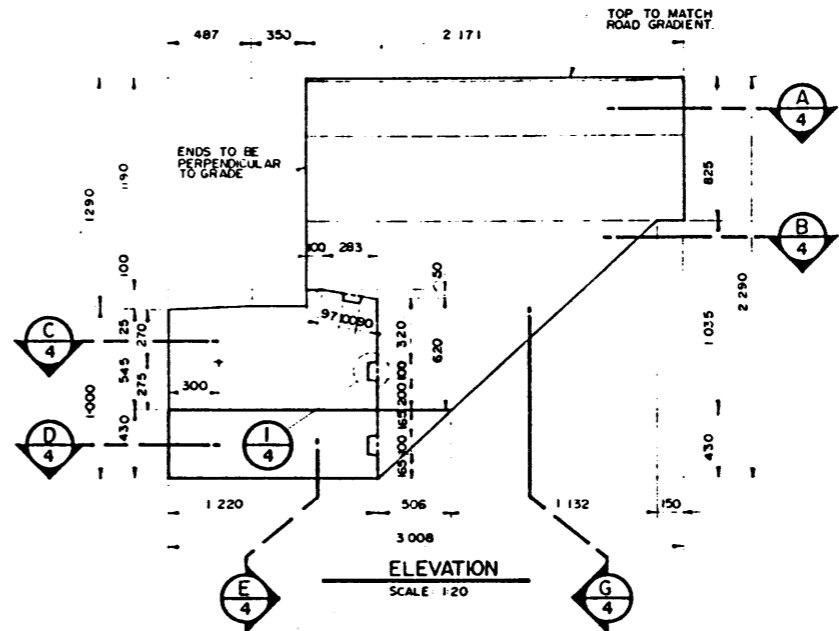

ELEVATION
SCALE 1/20

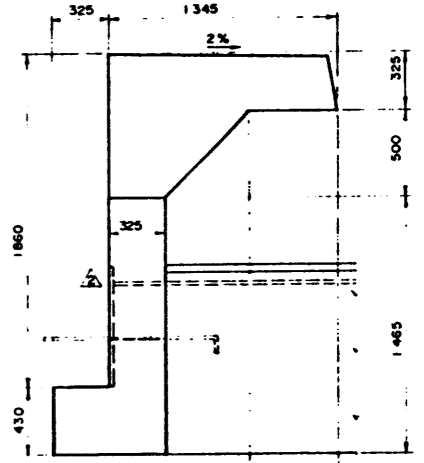

ELEVATION
SCALE 1/20

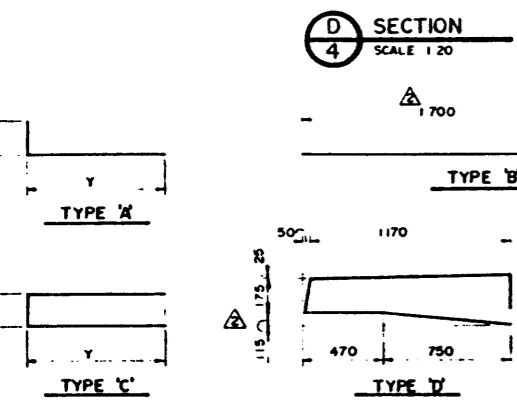

D SECTION
SCALE 1/20

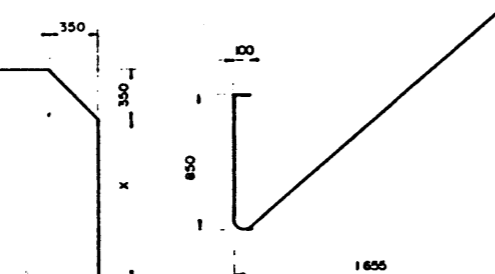

BAR TYPES
NOTE: ALL BAR DIMENSIONS ARE OUT TO OUT

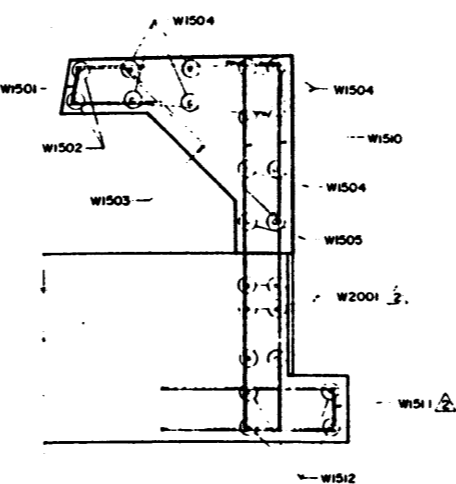

E SECTION
SCALE 1/20

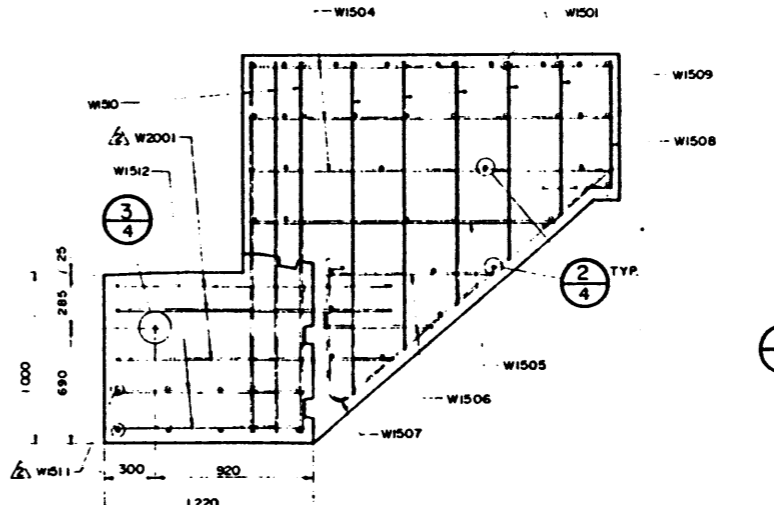

F SECTION
SCALE 1/20

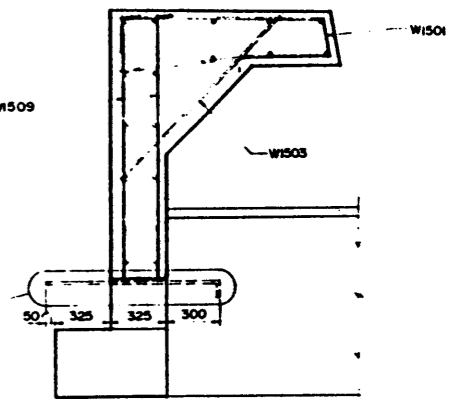

G SECTION
SCALE 1/20

BAR LIST FOR 4 WINGWALLS								
MARK	SIZE	NO.	TYPE	X	Y	LENGTH	MASS	REMARKS
W1501	15M	28	'D'	-	-	2 810	124	
W1502	15M	8	'B'	VARIABLES	-	VARIABLES	39	X=4-845, 4-895
W1503	15M	32	STR	-	-	VARIABLES	63	4-1120, 28-1 270
W1504	15M	40	STR	-	-	2 050	129	
W1505	15M	8	STR	-	-	1 760	22	
W1506	15M	16	'A'	100	VARIABLES	VARIABLES	22	Y=8-610, 8-960
W1507	15M	8	'E'	-	-	3 170	40	
W1508	15M	8	'X'	400	710	1 110	14	
W1509	15M	40	STR	-	-	VARIABLES	87	LENGTH= 8-860, 8-1120, 8-1 380, 8-1640, 8-1900
W1510	15M	24	'X'	100	2 135	2 235	84	
W1511	15M	20	'C'	250	1 000	2 250	71	
W1512	15M	16	STR	-	-	1 100	28	
W2001	20M	12	'C'	170	1 600	3 370	95	
TOTAL (kg)							818	

NOTE: # BY ERECTOR

THE ASSOCIATION OF PROFESSIONAL ENGINEERS OF ALBERTA PERMIT NO. 1220			
DOLTER PARISH TRIMBLE LTD.			
NO.	DATE	DESCRIPTION	BY
	JULY, 1981	ANCHOR BOLTS ADDED	C.D.P.
	APRIL, 1981	REINFORCEMENT CHANGED	G.J.P.
	JAN., 1981	DIMENSIONS CHANGED	G.J.P.

Dolter Parish Trimble Ltd. CONSULTING ENGINEERS			
DATE	SPT DWG.	DWN. BY	LOCATION
DEC, 1980	100-6-42	A.S.B.	HIGHWAY



ALBERTA TRANSPORTATION
BRIDGE AND STRUCTURAL ENGINEERING BRANCH
KANANASKIS COUNTRY BRIDGES
WINGWALL DETAILS - MAJOR BRIDGES

SHT. NO. OF
FILE NO.
HWY. STA.
DWG. NO. S-1467