

STEEL SHEET PILING

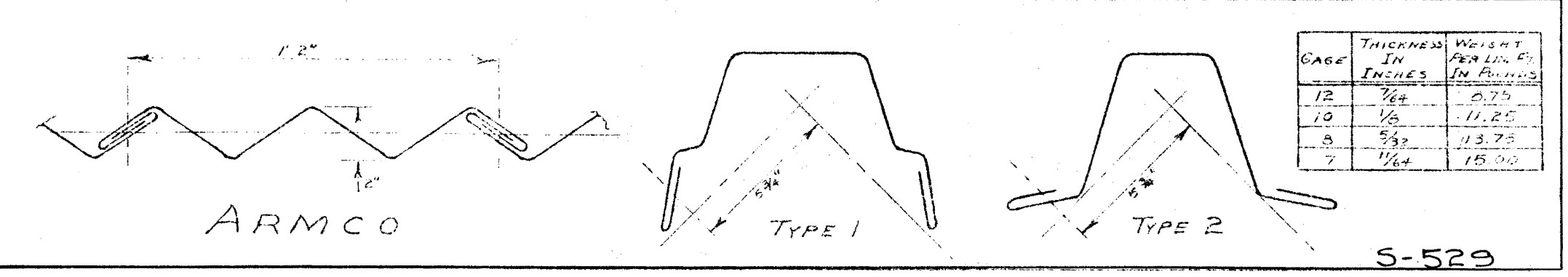
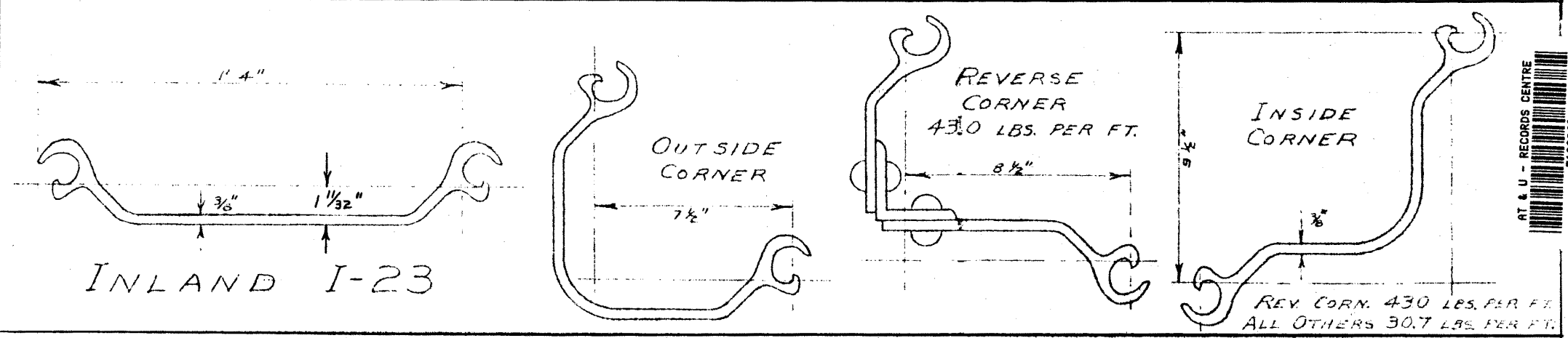
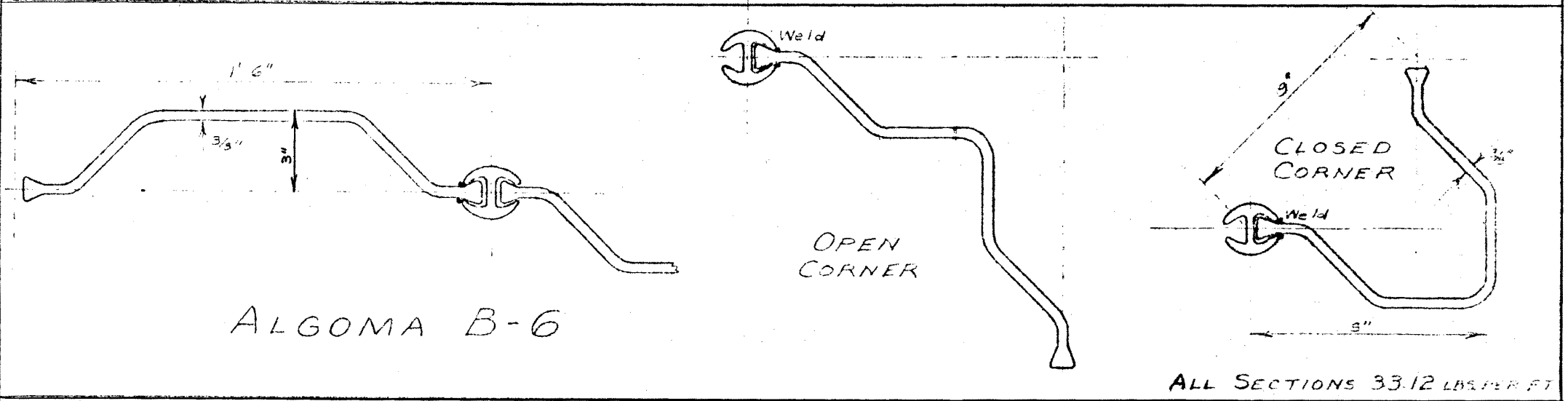
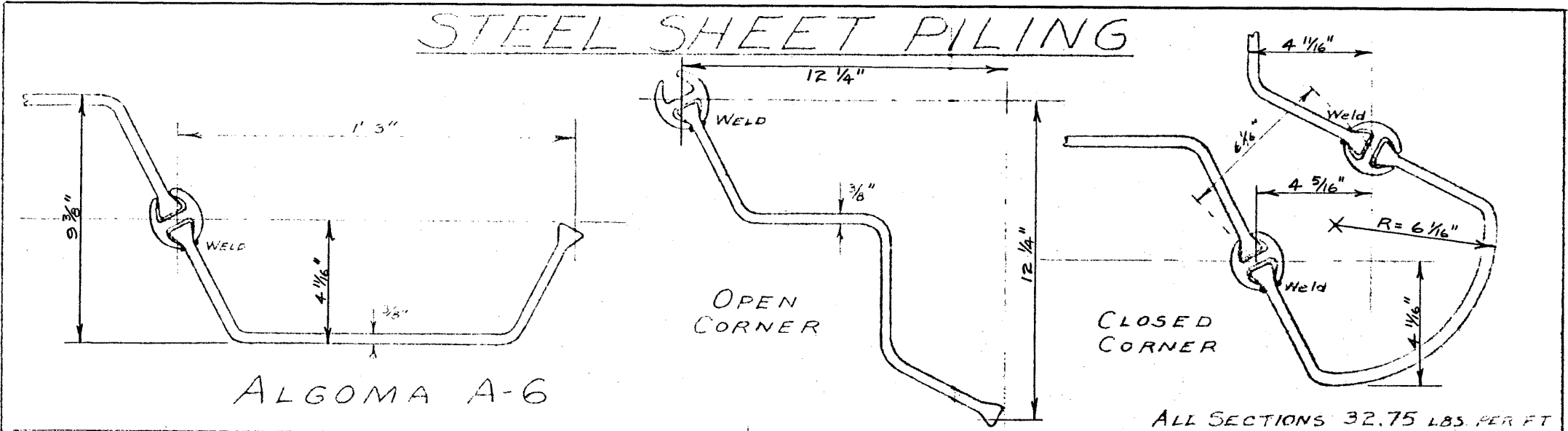

AT & U - RECORDS CENTRE
F106643

Superseded
By S-529A

5279 D.S.L. 20-1-52